

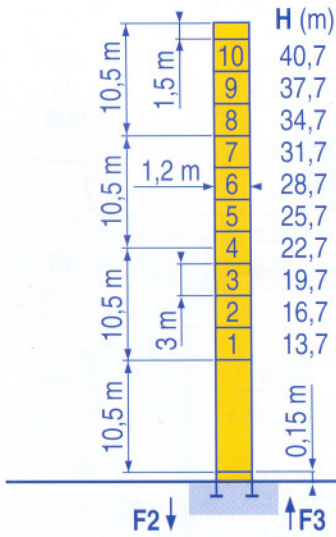





20 m → 40 m



P 12 C

F2 ● 60 t	■ 111 t
F3 ● 47 t	■ 99 t
▲ 15,5 t	

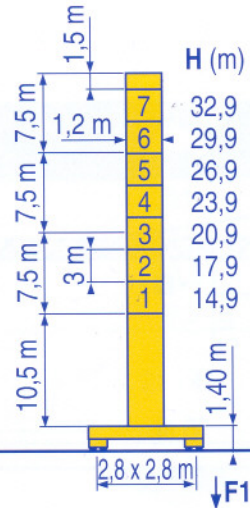

ZE 12 A

F1 ● 40 t	■ 57 t
▲ 18 t	

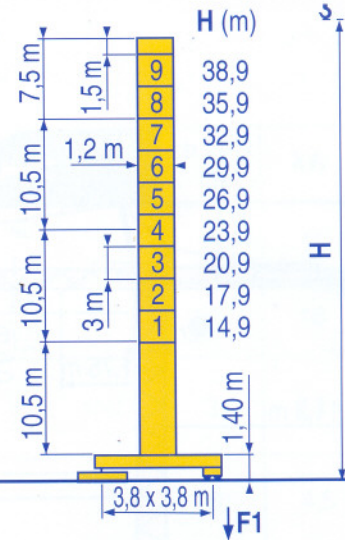

ZF 12 A / ZFC 12 A

F1 ● 38 t	■ 54 t
▲ 20,5 t	

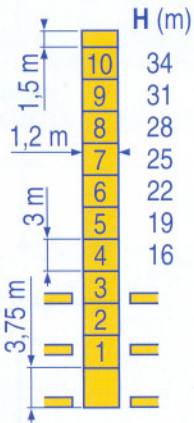

B 125 A / P 12 B

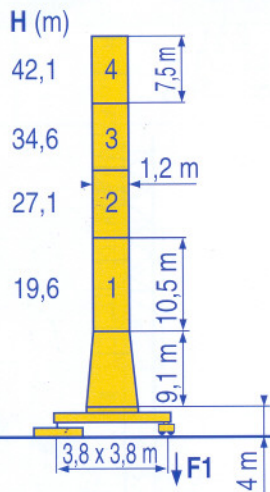

ZC 16 A / ZFC 16 A

F1 ● 42 t	■ 64 t
▲ 23 t	

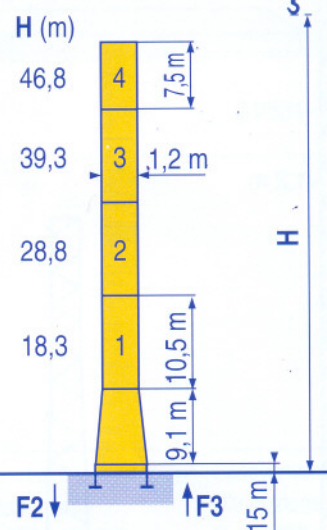

P 16 A

F2 ● 52 t	■ 103 t
F3 ● 39 t	■ 91 t
▲ 19 t	

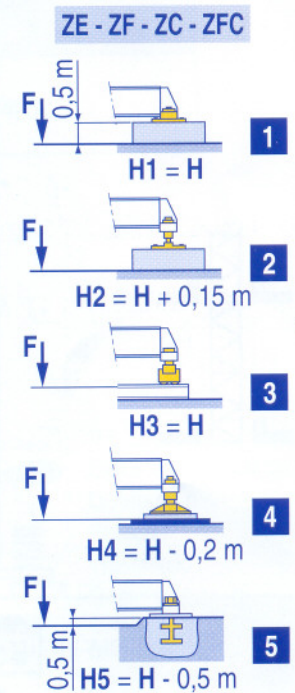

LWJ 2

	Voir télescopage sur dalles		Siehe Kletterkrane im Gebäude		See climbing crane		Vea grua trepadora		Consultare gru in cavedio		Ver telescopagem sobre lajes
●	Réactions en service	●	Reaktionskräfte in Betrieb	●	Reactions in service	●	Reacciones en servicio	●	Reazioni in servizio	●	Reações em serviço
■	Réactions hors service	■	Reaktionskräfte außer Betrieb	■	Reactions out of service	■	Reacciones fuera de servicio	■	Reazioni fuori servizio	■	Reações fora de serviço
▲	A vide sans lest (ni train de transport) avec flèche et hauteur maximum.	▲	Ohne Last, Ballast (und Transportachse), mit Maximalausleger und Maximalhöhe.	▲	Without load, ballast (or transport axes), with maximum jib and maximum height.	▲	Sin carga, sin lastre, (ni tren de transporte), flecha y altura máxima.	▲	A vuoto, senza zavorra (ne assali di trasporto) con braccio massimo e altezza massima.	▲	Sem carga (nem trem de transporte)-sem lastro com lança e altura máximas.



40 m	1,75 ▶	18,6	20	22	25	27	30	32	35	37	40 m
		2,5	2,3	2,1	1,78	1,62	1,43	1,32	1,18	1,1	1 t
35 m	1,75 ▶	20,1	22	25	27	30	32	35 m			
		2,5	2,25	1,95	1,78	1,57	1,45	1,3 t			
30 m	1,75 ▶	20,5	22	25	27	30 m					
		2,5	2,3	1,98	1,81	1,6 t					
25 m	1,75 ▶	20,6	22	25 m							
		2,5	2,3	2 t							
20 m	1,75 ▶	20 m									
		2,5 t									

LWJ1

B 125 A

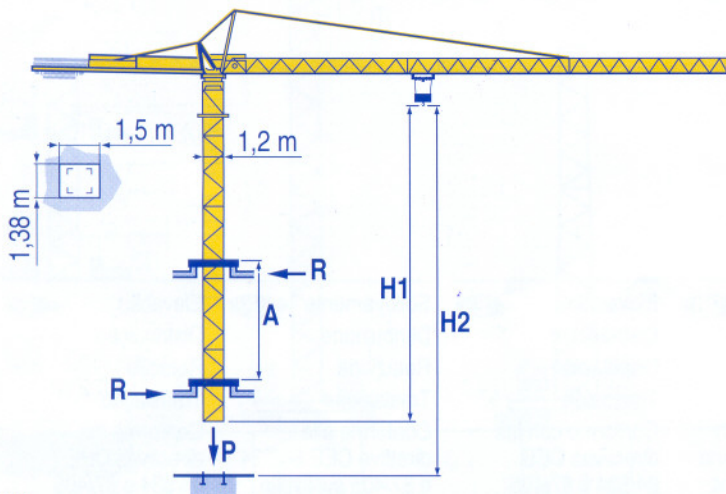

LWJ1

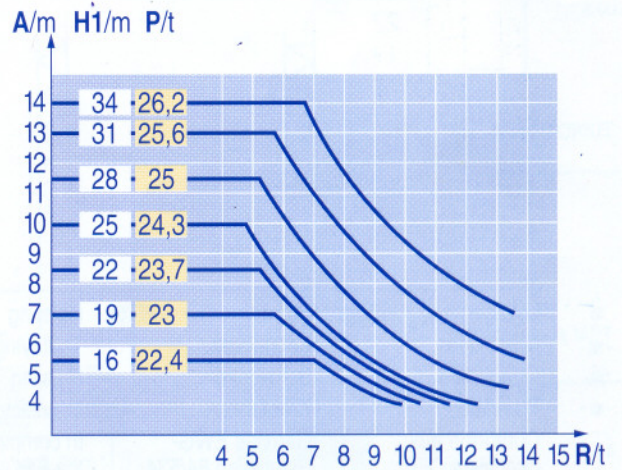

<b>A</b>	Distance entre cadres	F	Abstand zwischen den Rahmen	D	Distance between collars	GB	Distancia entre marcos	E	Distanza fra i telai	I	Distância entre quadros	P
<b>H1</b>	Hauteur grue		Kranhöhe		Crane height		Altura grúa		Altezza gru		Altura da grua	
<b>P</b>	Poids de la grue (en service)		Krangewicht (in Betrieb)		Crane weight (in service)		Peso de la grúa (en servicio)		Peso della gru (in servizio)		Peso da grua (em serviço)	
<b>R</b>	Réaction horizontale		Horizontalkräfte		Horizontal reaction		Reaccion horizontal		Reazione orizzontale		Reacção horizontal	



					ch - PS hp	kW		
	15 PC 13-5	m/min	7,1	21	42	15	11	130 m
		t	2,5	2,5	1,3			
	25 PC 13-7	m/min	7,9	31,5	63	25	18	229 m
		t	2,5	2,5	1,3			
	3 D2 V5	m/min	21 - 42			3	2,2	
	RCV 40	tr/min U/min rpm	0 → 0,8			6	4,5	
	TVD 324	m/min	26			2 x 4	2 x 2,9	
	RT 224	m/min	25			2 x 4	2 x 2,9	

CEI 38	IEC 38	kVA	
400 V (+6% -10%) 50 Hz		15 PC : 25 kVA 25 PC : 35 kVA	84/534 - 87/405

LUJ 3

	Levage	F	Heben	D	Hoisting	GB	Elevación	E	Sollevamento	I	Elevação	P
	Distribution		Katzfahren		Trolleying		Distribución		Distribuzione		Distribuição	
	Orientation		Schwenken		Slewing		Orientación		Rotazione		Rotação	
	Translation		Kranfahren		Travelling		Traslación		Traslazione		Translação	
	Conforme aux directives CEE 84/534 et 87/405 sur le niveau acoustique		Gemäss EWG-Richtlinien 84/534 und 87/405 für den Schall-Leistungspegel		In compliance with the EEC 84/534 and 87/405 Instructions on noise level		Conforme con las directivas CEE 84/534 y 87/405 sobre el nivel acustico		Conforme alle direttive CEE 84/534 e 87/405 sul livello acustico		Conforme as directivas CEE 84/534 e 87/405 sobre o nível acústico	



Document commercial non contractuel. Pour toute information technique se référer à la notice correspondante

Unverbindliches Vertriebsdokument. Für technische Informationen, siehe die entsprechenden Anweisungen.

This commercial document is not legally binding. For any technical information, please refer to the corresponding instructions.

Documento commercial non contractuel. Para cualquier información técnica, ver la noticia correspondiente.

Documento commerciale non vincolante, per tutte le informazioni tecniche fare riferimento al catalogo istruzioni

Documento comercial não contratual. Para qualquer informação técnica complementar consultar as respectivas instruções

**BACCARANI**  
**MACCHINE EDILI S.R.L**  
Viale Europa n° 44  
41011 CAMPOGALLIANO (MO)  
Cod. Fisc. e P. IVA 0280033036  
Cap. Soc. € 50.000,00 i.v.

**POTAIN**

18.Rue de Charbonnières, B.P. 173  
F-69132 ECULLY Cedex  
Tél. (33)04.72.18.20.20  
Fax (33)04.72.18.20.00  
http://www.potain.com  
E-mail : mkt@potain.fr

Manitowoc Crane Group

**Deutschland**  
POTAIN GmbH Tel : 06.1.05.70.40  
**Italia**  
POTAIN S.p.A. Tel : 0.331.49.33.11  
**Portugal**  
POTAIN Portugal Tel : 22.968.08.89  
**Singapore**  
MANITOWOC POTAIN PTE LTD Tel : 227.15.50

Copyright.Reproduction interdite © POTAIN 2000

**CITY CRANE MC 50 B**

Réf. 2000.36 LUJ 6